

TLP521GB, TLP521-2GB, TLP521-4GB  
 TLP521, TLP521-2, TLP521-4



**HIGH DENSITY MOUNTING  
 PHOTOTRANSISTOR  
 OPTICALLY COUPLED ISOLATORS**

**APPROVALS**

- UL recognised, File No. E91231

**DESCRIPTION**

The TLP521, TLP521-2, TLP521-4 series of optically coupled isolators consist of infrared light emitting diodes and NPN silicon photo transistors in space efficient dual in line plastic packages.

**FEATURES**

- Options :-  
 10mm lead spread - add G after part no.  
 Surface mount - add SM after part no.  
 Tape&reel - add SMT&R after part no.
- High Current Transfer Ratio ( 50% min)
- High Isolation Voltage (5.3kV<sub>RMS</sub>, 7.5kV<sub>PK</sub>)
- High BV<sub>CEO</sub> ( 55Vmin )
- All electrical parameters 100% tested
- Custom electrical selections available

**APPLICATIONS**

- Computer terminals
- Industrial systems controllers
- Measuring instruments
- Signal transmission between systems of different potentials and impedances

**TLP521**

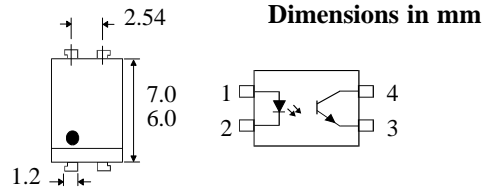

**TLP521-2**

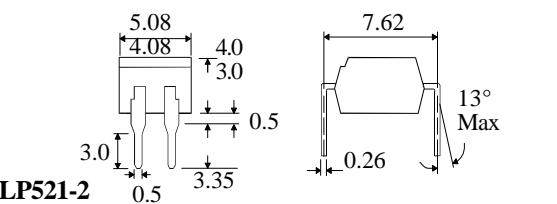

**TLP521-4**

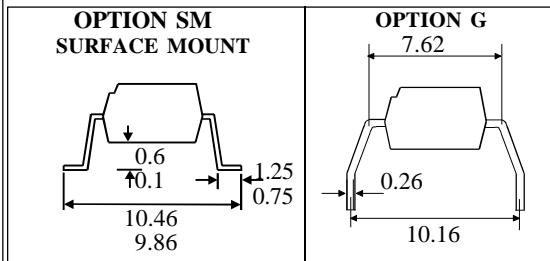
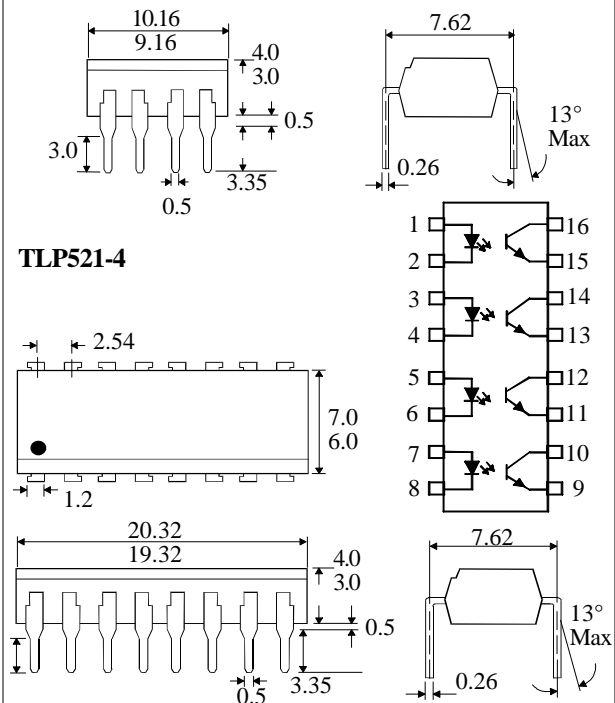

**ISOCOM COMPONENTS LTD**  
 Unit 25B, Park View Road West,  
 Park View Industrial Estate, Brenda Road  
 Hartlepool, Cleveland, TS25 1YD  
 Tel: (01429) 863609 Fax :(01429) 863581

**ISOCOM INC**  
 1024 S. Greenville Ave, Suite 240,  
 Allen, TX 75002 USA  
 Tel: (214)495-0755 Fax: (214)495-0901  
 e-mail info@isocom.com  
 http://www.isocom.com

**ABSOLUTE MAXIMUM RATINGS**  
(25°C unless otherwise specified)

Storage Temperature \_\_\_\_\_ -55°C to + 125°C  
 Operating Temperature \_\_\_\_\_ -55°C to + 100°C  
 Lead Soldering Temperature  
 (1/16 inch (1.6mm) from case for 10 secs) 260°C

**INPUT DIODE**

Forward Current \_\_\_\_\_ 50mA  
 Reverse Voltage \_\_\_\_\_ 5V  
 Power Dissipation \_\_\_\_\_ 70mW

**OUTPUT TRANSISTOR**

Collector-emitter Voltage  $BV_{CEO}$  \_\_\_\_\_ 55V  
 Emitter-collector Voltage  $BV_{ECO}$  \_\_\_\_\_ 6V  
 Power Dissipation \_\_\_\_\_ 150mW

**POWER DISSIPATION**

Total Power Dissipation \_\_\_\_\_ 200mW  
 (derate linearly 2.67mW/°C above 25°C)

**ELECTRICAL CHARACTERISTICS (  $T_A = 25^\circ\text{C}$  Unless otherwise noted )**

PARAMETER		MIN	TYP	MAX	UNITS	TEST CONDITION
Input	Forward Voltage ( $V_F$ )	1.0	1.15	1.3	V	$I_F = 10\text{mA}$
	Reverse Voltage ( $V_R$ )	5			V	$I_R = 10\mu\text{A}$
	Reverse Current ( $I_R$ )			10	$\mu\text{A}$	$V_R = 5\text{V}$
Output	Collector-emitter Breakdown ( $BV_{CEO}$ ) (Note 2)	55			V	$I_C = 0.5\text{mA}$
	Emitter-collector Breakdown ( $BV_{ECO}$ )	6			V	$I_E = 100\mu\text{A}$
	Collector-emitter Dark Current ( $I_{CEO}$ )			100	nA	$V_{CE} = 24\text{V}$
Coupled	Current Transfer Ratio (CTR) (Note 2) TLP521, TLP521-2, TLP521-4	50		600	%	$5\text{mA } I_F, 5\text{V } V_{CE}$
	CTR selection available BL	200		600	%	
	GB	100		600	%	
	GB	30			%	$1\text{mA } I_F, 0.4\text{V } V_{CE}$
	Collector-emitter Saturation Voltage $V_{CE(SAT)}$ -GB			0.4	V	$8\text{mA } I_F, 2.4\text{mA } I_C$
	Input to Output Isolation Voltage $V_{ISO}$	5300		0.4	V	$1\text{mA } I_F, 0.2\text{mA } I_C$
		7500			$V_{RMS}$	See note 1
	Input-output Isolation Resistance $R_{ISO}$	$5 \times 10^{10}$			$V_{PK}$	See note 1
	Rise Time tr		2		$\mu\text{s}$	$V_{IO} = 500\text{V}$ (note 1)
	Fall Time tf		3		$\mu\text{s}$	$V_{CC} = 10\text{V}$ ,
Turn-on Time ton		3		$\mu\text{s}$	$I_C = 2\text{mA}, R_L = 100\Omega$	
Turn-off Time toff		3		$\mu\text{s}$		

Note 1 Measured with input leads shorted together and output leads shorted together.

Note 2 Special Selections are available on request. Please consult the factory.

**Collector Power Dissipation vs. Ambient Temperature**



**Collector Current vs. Low Collector-emitter Voltage**

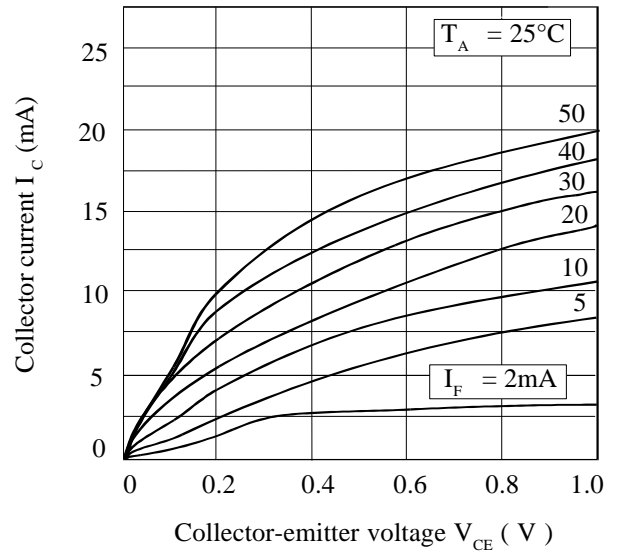

**Forward Current vs. Ambient Temperature**

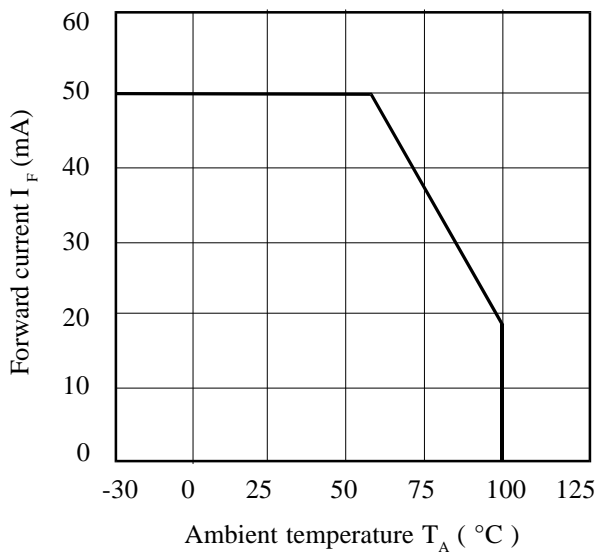

**Collector Current vs. Collector-emitter Voltage**

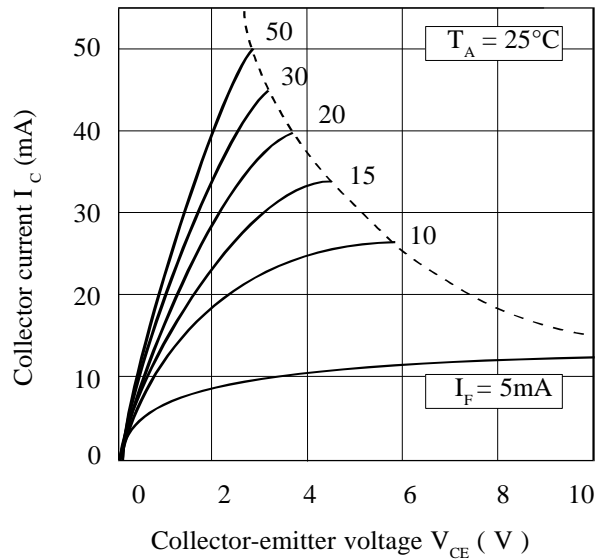

**Collector-emitter Saturation Voltage vs. Ambient Temperature**

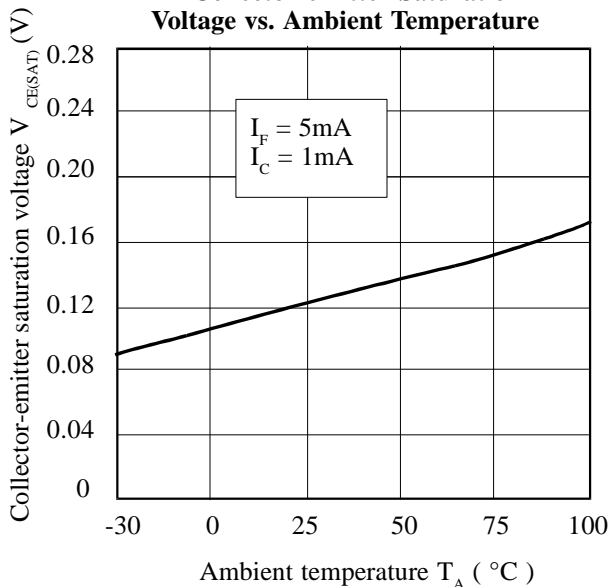

**Current Transfer Ratio vs. Forward Current**

